

Series 50 Shapes Data

Name Full Base Block - 60 cm

| | |
|----------------|---------------------------------|
| Unit ID | Dimensions |
| FB24 | 40.64 cm x 121.92 cm x 60.96 cm |

| | | |
|---------------|---------------------|-------------------|
| Weight | Volume | Coverage |
| 660.88 kg | .284 m ³ | .5 m ² |

Batter
3.6°



Name Full Middle Block - 60 cm

| | |
|----------------|---------------------------------|
| Unit ID | Dimensions |
| FM24 | 40.64 cm x 121.92 cm x 60.96 cm |

| | | |
|---------------|---------------------|-------------------|
| Weight | Volume | Coverage |
| 640.02 kg | .276 m ³ | .5 m ² |

Batter
3.6°



Name Full Base Block - 100 cm

| | |
|----------------|---------------------------------|
| Unit ID | Dimensions |
| FB39 | 40.64 cm x 121.92 cm x 99.06 cm |

| | | |
|---------------|---------------------|-------------------|
| Weight | Volume | Coverage |
| 1032.38 kg | .445 m ³ | .5 m ² |

Batter
3.6°

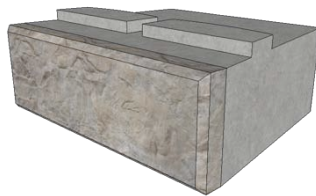

Name Full Middle Block - 100 cm

| | |
|----------------|---------------------------------|
| Unit ID | Dimensions |
| FM39 | 40.64 cm x 121.92 cm x 99.06 cm |

| | | |
|---------------|--------------------|-------------------|
| Weight | Volume | Coverage |
| 998.36 kg | .43 m ³ | .5 m ² |

Batter
3.6°

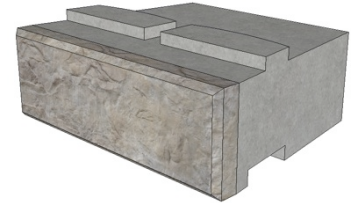

Name Full Base Block - 115 cm

| | |
|----------------|---------------------------------|
| Unit ID | Dimensions |
| FB45 | 40.64 cm x 121.92 cm x 114.3 cm |

| | | |
|---------------|---------------------|-------------------|
| Weight | Volume | Coverage |
| 1156.66 kg | .498 m ³ | .5 m ² |

Batter
3.6°



Name Full Middle Block - 115cm

| | |
|----------------|---------------------------------|
| Unit ID | Dimensions |
| FM45 | 40.64 cm x 121.92 cm x 114.3 cm |

| | | |
|---------------|---------------------|-------------------|
| Weight | Volume | Coverage |
| 1129.9 kg | .486 m ³ | .5 m ² |

Batter
3.6°



Name Full Base Block - 150 cm

| | |
|----------------|---------------------------------|
| Unit ID | Dimensions |
| FB60 | 40.64 cm x 121.92 cm x 152.4 cm |

| | | |
|---------------|---------------------|-------------------|
| Weight | Volume | Coverage |
| 1439.24 kg | .619 m ³ | .5 m ² |

Batter
3.6°



Name Full Middle Block - 150 cm

| | |
|----------------|---------------------------------|
| Unit ID | Dimensions |
| FM60 | 40.64 cm x 121.92 cm x 152.4 cm |

| | | |
|---------------|---------------------|-------------------|
| Weight | Volume | Coverage |
| 1412.93 kg | .608 m ³ | .5 m ² |

Batter
3.6°



Name Full Base Block - 195 cm

| Unit ID | Dimensions | |
|-----------|----------------------------------|-------------------|
| FB78 | 40.64 cm x 121.92 cm x 198.12 cm | |
| Weight | Volume | Coverage |
| 1773.6 kg | .076m ³ | .5 m ² |

Batter
3.6



Name Full Middle Block - 195 cm

| Unit ID | Dimensions | |
|-----------|----------------------------------|-------------------|
| FM78 | 40.64 cm x 121.92 cm x 198.12 cm | |
| Weight | Volume | Coverage |
| 1747.3 kg | .075m ³ | .5 m ² |

Batter
3.6



Name Full Base Block - 210 cm

| Unit ID | Dimensions | |
|-----------|----------------------------------|-------------------|
| FB84 | 40.64 cm x 121.92 cm x 213.36 cm | |
| Weight | Volume | Coverage |
| 1884.5 kg | .080m ³ | .5 m ² |

Batter
3.6



Name Full Middle Block - 120 cm

| Unit ID | Dimensions | |
|-----------|----------------------------------|-------------------|
| FM84 | 40.64 cm x 121.92 cm x 213.36 cm | |
| Weight | Volume | Coverage |
| 1858.2 kg | .080m ³ | .5 m ² |

Batter
3.6



Name Full Channel Block

| Unit ID | Dimensions | |
|----------|---------------------------------|-------------------|
| chan | 40.64 cm x 121.92 cm x 60.96 cm | |
| Weight | Volume | Coverage |
| 641.4 kg | .028m ³ | .5 m ² |

Batter
26.5



Name Full Top Block - 60 cm

| Unit ID | Dimensions | |
|-----------|---------------------------------|-------------------|
| T24 | 40.64 cm x 121.92 cm x 60.96 cm | |
| Weight | Volume | Coverage |
| 440.44 kg | .19 m ³ | .5 m ² |

Batter
3.6°



Name Half Base Block - 60 cm

| Unit ID | Dimensions | |
|-----------|---------------------------------|--------------------|
| HB24 | 40.64 cm x 121.92 cm x 60.96 cm | |
| Weight | Volume | Coverage |
| 322.05 kg | .139 m ³ | .25 m ² |

Batter
3.6°



Name Half Middle Block - 60 cm

| Unit ID | Dimensions | |
|-----------|---------------------------------|--------------------|
| HM24 | 40.64 cm x 121.92 cm x 60.96 cm | |
| Weight | Volume | Coverage |
| 300.28 kg | .129 m ³ | .25 m ² |

Batter
3.6°



Name Half Middle Block - 100 cm
Unit ID HM39
Dimensions 40.64 cm x 60.96 cm x 99.06 cm
Weight 438.62 kg
Volume .189 m³
Coverage .25 m²
Batter 3.6°

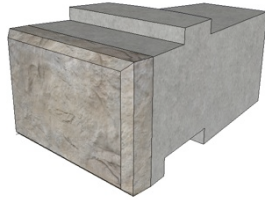

Name Half Middle Block - 115 cm
Unit ID HM45
Dimensions 40.64 cm x 60.96 cm x 114.3 cm
Weight 483.98 kg
Volume .208 m³
Coverage .25 m²
Batter 3.6°

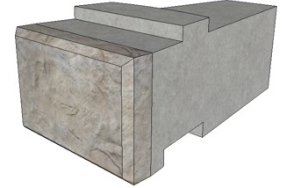

Name Half Top Block - 60 cm
Unit ID HT24
Dimensions 40.64 cm x 60.96 cm x 60.96 cm
Weight 207.75 kg
Volume .089 m³
Coverage .25 m²
Batter 3.6°



Name Left Corner Top Block
Unit ID LCT
Dimensions 40.64 cm x 121.92 cm x 60.96 cm
Weight 500.31 kg
Volume .215 m³
Coverage .75 m²
Batter 3.6°



Name Right Corner Top Block
Unit ID RCT
Dimensions 40.64 cm x 121.92 cm x 60.96 cm
Weight 500.31 kg
Volume .215 m³
Coverage .75 m²
Batter 3.6°



Name Reversible Corner Block
Unit ID C
Dimensions 40.64 cm x 121.92 cm x 60.96 cm
Weight 635.48 kg
Volume .274 m³
Coverage .75 m²
Batter 3.6°



Name Fitting Block - 60 cm
Unit ID FF24
Dimensions 40.64 cm x 121.92 cm x 60.96 cm
Weight 551.11 kg
Volume .237 m³
Coverage .5 m²
Batter 3.6°



Name Three Quarter Block - 60 cm
Unit ID TQM24
Dimensions 40.64 cm x 91.44 cm x 60.96 cm
Weight 470.38 kg
Volume .202 m³
Coverage .37 m²
Batter 3.6°

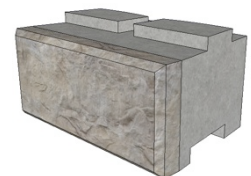

Name Three Quarter Block - 100 cm

| | | |
|----------------|--------------------------------|--------------------|
| Unit ID | Dimensions | |
| TQM39 | 40.64 cm x 91.44 cm x 99.06 cm | |
| Weight | Volume | Coverage |
| 719.4 kg | .31 m ³ | .37 m ² |
| Batter | | |
| 3.6° | | |



Name Capstone

| | | |
|----------------|---------------------------------|--------------------|
| Unit ID | Dimensions | |
| CAP | 16.51 cm x 121.92 cm x 66.04 cm | |
| Weight | Volume | Coverage |
| 272.16 kg | .117 m ³ | .20 m ² |
| Batter | | |
| N/A | | |



Name End Capstone

| | | |
|----------------|---------------------------------|--------------------|
| Unit ID | Dimensions | |
| ECAP | 16.51 cm x 121.92 cm x 66.04 cm | |
| Weight | Volume | Coverage |
| 272.16 kg | .117 m ³ | .20 m ² |
| Batter | | |
| N/A | | |



Name Full-High Cap Middle Block

| | | |
|----------------|---------------------------------|---------------------|
| Unit ID | Dimensions | |
| FHCAPM | 40.64 cm x 121.92 cm x 60.96 cm | |
| Weight | Volume | Coverage |
| 661.78 kg | .285 m ³ | 1.00 m ² |
| Batter | | |
| 0° | | |



Name Full-High Cap End Block

| | | |
|----------------|---------------------------------|---------------------|
| Unit ID | Dimensions | |
| FHCAPE | 40.64 cm x 121.92 cm x 60.96 cm | |
| Weight | Volume | Coverage |
| 657.71 kg | .283 m ³ | 1.25 m ² |
| Batter | | |
| 0° | | |



Name Step Unit

| | | |
|----------------|---------------------------------|--------------------|
| Unit ID | Dimensions | |
| STEP | 16.51 cm x 121.92 cm x 66.04 cm | |
| Weight | Volume | Coverage |
| 308.44 kg | .133 m ³ | .20 m ² |
| Batter | | |
| N/A | | |



Name Plinth Block

| | | |
|----------------|---------------------------------|--------------------|
| Unit ID | Dimensions | |
| PLB | 40.64 cm x 60.96 cm x 119.38 cm | |
| Weight | Volume | Coverage |
| 674.04 kg | .290 m ³ | .25 m ² |
| Batter | | |
| 3.6° | | |



Name Full Fence Base Block

| | | |
|----------------|---------------------------------|---------------------|
| Unit ID | Dimensions | |
| FFB | 40.64 cm x 121.92 cm x 60.96 cm | |
| Weight | Volume | Coverage |
| 683.11 kg | .294 m ³ | 1.00 m ² |
| Batter | | |
| 0° | | |



Name Full Fence Middle Block

Unit ID **Dimensions**
 FFM 40.64 cm x 121.92 cm x 60.96 cm

Weight **Volume** **Coverage**
 635.03 kg .274 m³ 1.00 m²

Batter
 0°



Name Full Fence Base End Block - Male

Unit ID **Dimensions**
 FFBEM 40.64 cm x 121.92 cm x 60.96 cm

Weight **Volume** **Coverage**
 742.08 kg .319 m³ 1.25 m²

Batter
 0°

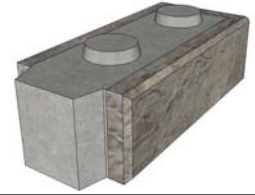

Name Full Fence Base End Block - Female

Unit ID **Dimensions**
 FFBEF 40.64 cm x 121.92 cm x 60.96 cm

Weight **Volume** **Coverage**
 641.83 kg .276 m³ 1.25 m²

Batter
 0°

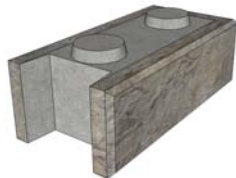

Name Full Fence Middle End Block - Male

Unit ID **Dimensions**
 FFMEM 40.64 cm x 121.92 cm x 60.96 cm

Weight **Volume** **Coverage**
 698.53 kg .301 m³ 1.25 m²

Batter
 0°

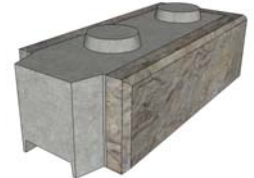

Name Full Fence Middle End Block-Female

Unit ID **Dimensions**
 FFMEF 40.64 cm x 121.92 cm x 60.96 cm

Weight **Volume** **Coverage**
 597.83 kg .257 m³ 1.25 m²

Batter
 0°



Name Half Fence Base Block

Unit ID **Dimensions**
 HFB 40.64 cm x 60.96 cm x 60.96 cm

Weight **Volume** **Coverage**
 332.03 kg .143 m³ .5 m²

Batter
 0°



Name Half Fence Middle Block

Unit ID **Dimensions**
 HFM 40.64 cm x 60.96 cm x 60.96 cm

Weight **Volume** **Coverage**
 308.9 kg .133 m³ .5 m²

Batter
 0°



Name Half Fence End Block

Unit ID **Dimensions**
 HFE 40.64 cm x 60.96 cm x 60.96 cm

Weight **Volume** **Coverage**
 391 kg .168 m³ .75 m²

Batter
 0°



Name Full Guardrail Base Block

| | |
|----------------|---------------------------------|
| Unit ID | Dimensions |
| FGB | 40.64 cm x 121.92 cm x 60.96 cm |

| | | |
|---------------|---------------------|---------------------|
| Weight | Volume | Coverage |
| 659.52 kg | .283 m ³ | 1.00 m ² |

Batter
0°



Name Full Guardrail Middle Block

| | |
|----------------|---------------------------------|
| Unit ID | Dimensions |
| FGM | 40.64 cm x 121.92 cm x 60.96 cm |

| | | |
|---------------|---------------------|---------------------|
| Weight | Volume | Coverage |
| 615.52 kg | .265 m ³ | 1.00 m ² |

Batter
0°



Name Full Guardrail End Block

| | |
|----------------|---------------------------------|
| Unit ID | Dimensions |
| FGE | 40.64 cm x 121.92 cm x 60.96 cm |

| | | |
|---------------|---------------------|---------------------|
| Weight | Volume | Coverage |
| 678.57 kg | .292 m ³ | 1.25 m ² |

Batter
0°



Name Half Guardrail Base Block

| | |
|----------------|--------------------------------|
| Unit ID | Dimensions |
| HGB | 40.64 cm x 60.96 cm x 60.96 cm |

| | | |
|---------------|---------------------|-------------------|
| Weight | Volume | Coverage |
| 320.24 kg | .138 m ³ | .5 m ² |

Batter
0°

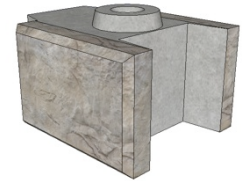

Name Half Guardrail Middle Block

| | |
|----------------|--------------------------------|
| Unit ID | Dimensions |
| HGM | 40.64 cm x 60.96 cm x 60.96 cm |

| | | |
|---------------|---------------------|-------------------|
| Weight | Volume | Coverage |
| 299.37 kg | .129 m ³ | .5 m ² |

Batter
0°

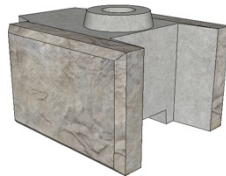

Name Half Guardrail End Block

| | |
|----------------|--------------------------------|
| Unit ID | Dimensions |
| HGE | 40.64 cm x 60.96 cm x 60.96 cm |

| | | |
|---------------|---------------------|--------------------|
| Weight | Volume | Coverage |
| 381.47 kg | .164 m ³ | .75 m ² |

Batter
0°

